



**УМНЫЙ
ДОМ**





Smartphone Users WorldWide, billions

www.eMarketer.com

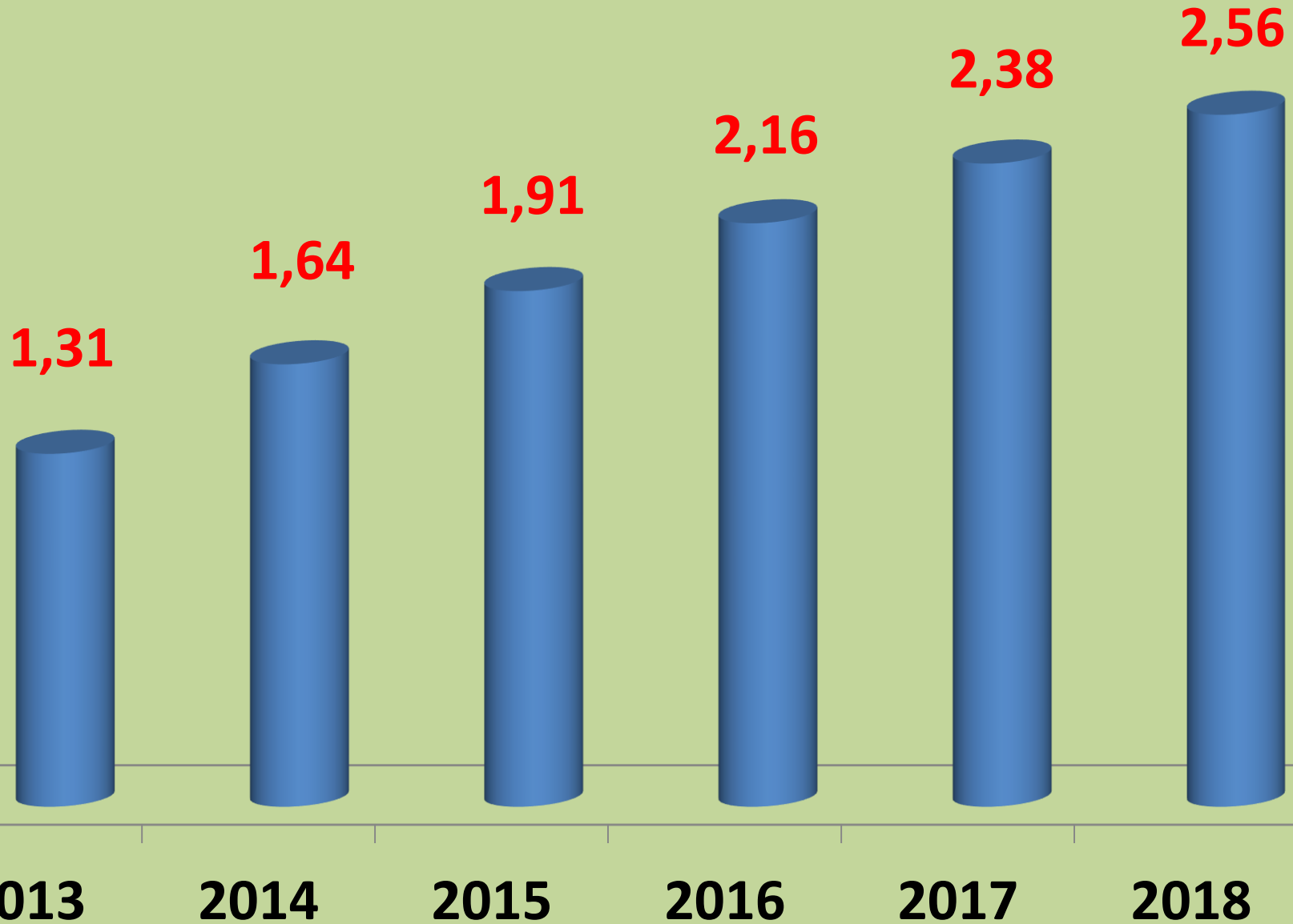



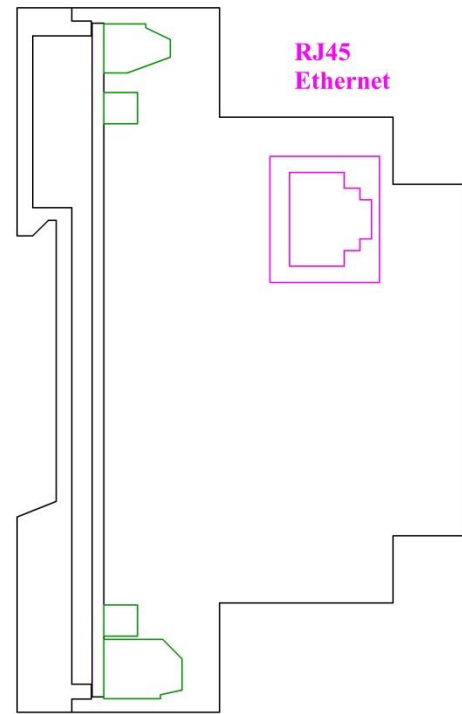
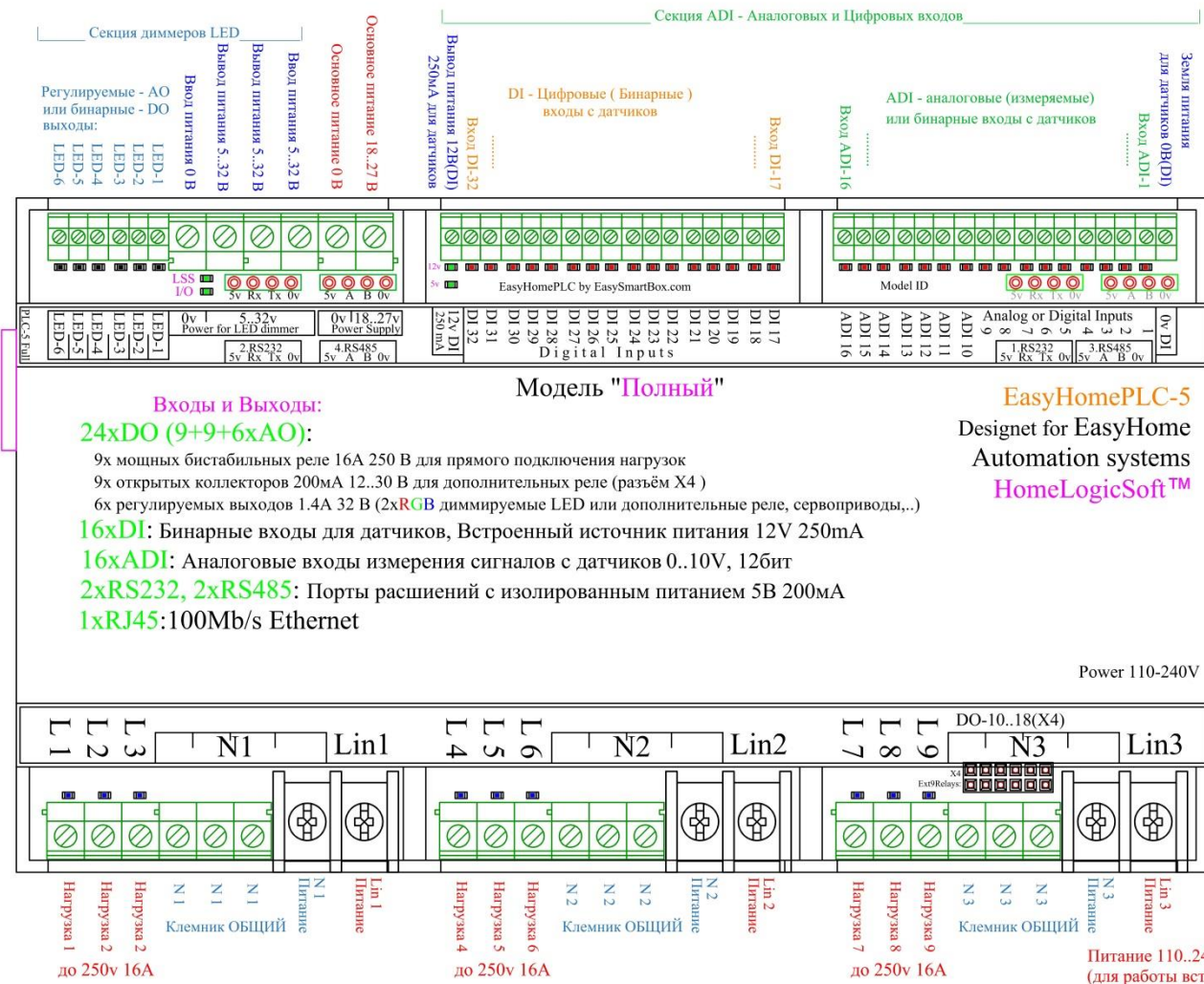

Светодиоды "12v" и "5v" индицируют работу встроенных блоков питания.
Светодиод "LSS" индицирует подключение питания на секцию LED диммеров.
Светодиод "I/O" индицирует работу микропроцессора.
Светодиоды "L1..L9" - отображают переключения и тест включенных реле.



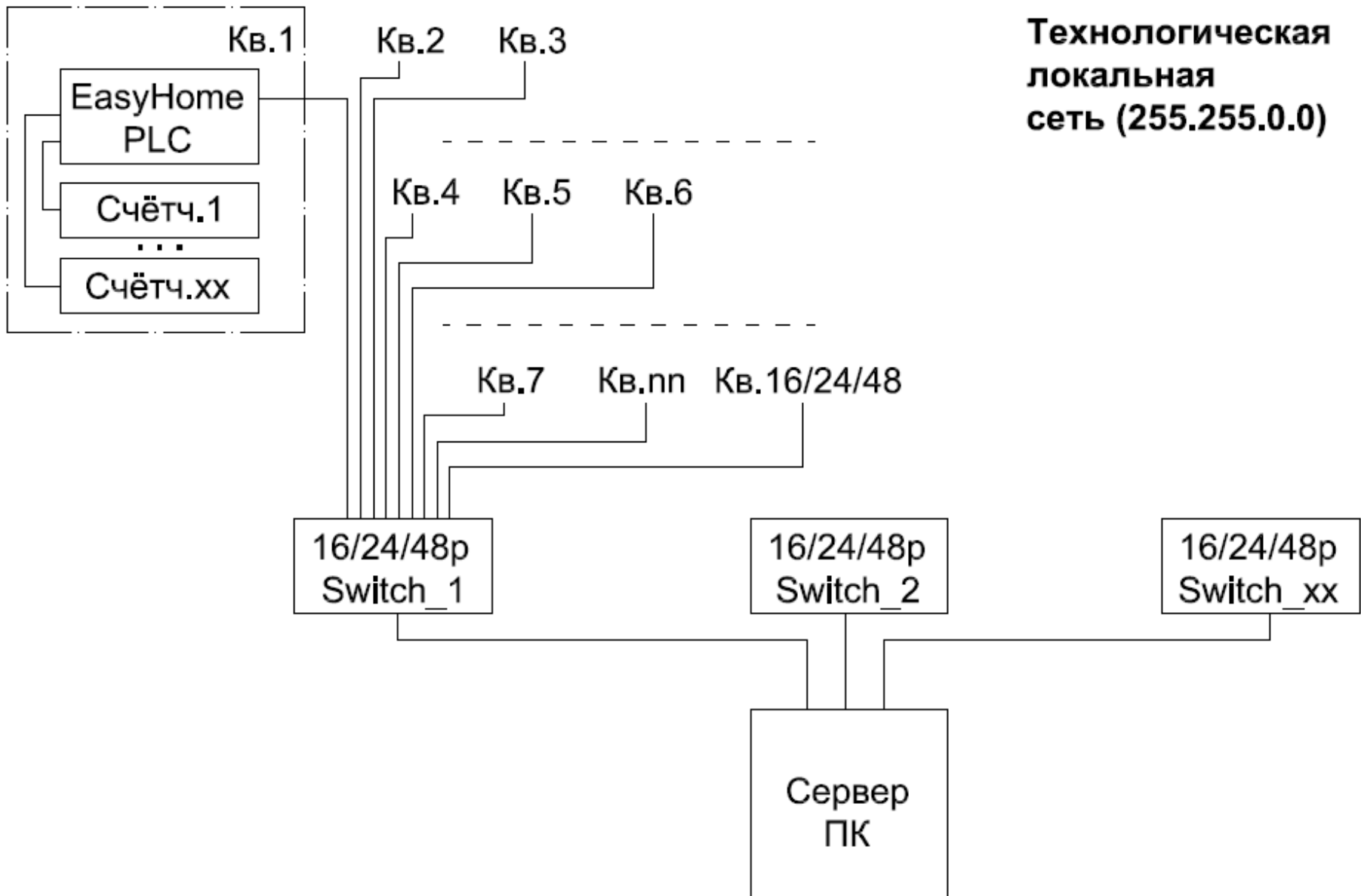

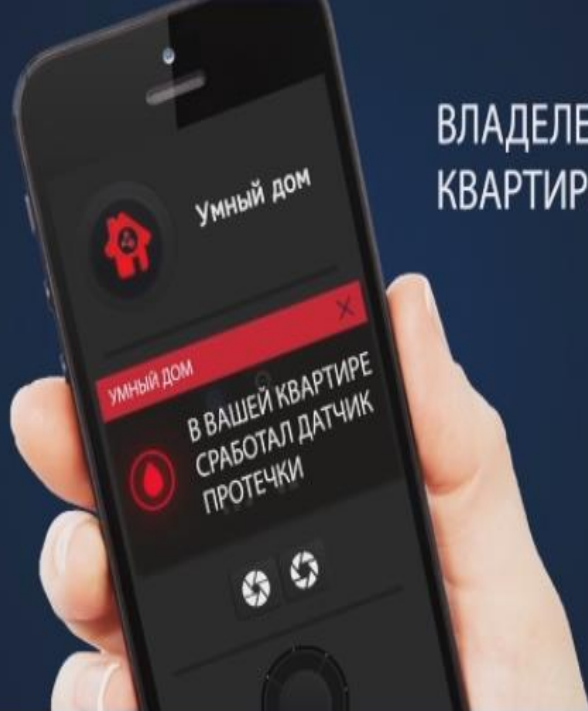

ВЛАДЕЛЕЦ
КВАРТИРЫ



ВЛАДЕЛЕЦ КВАРТИРЫ

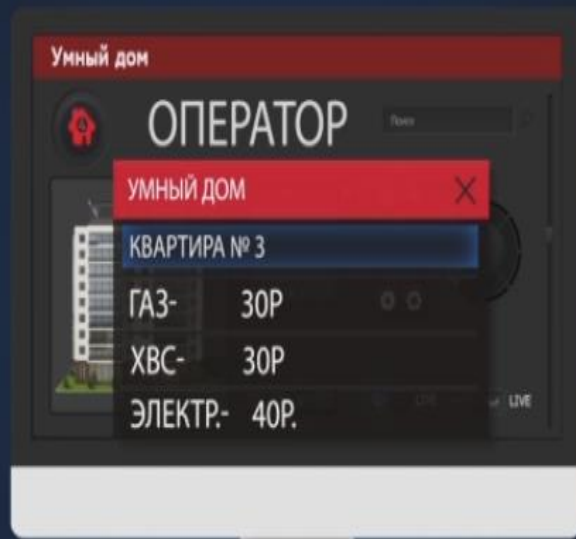
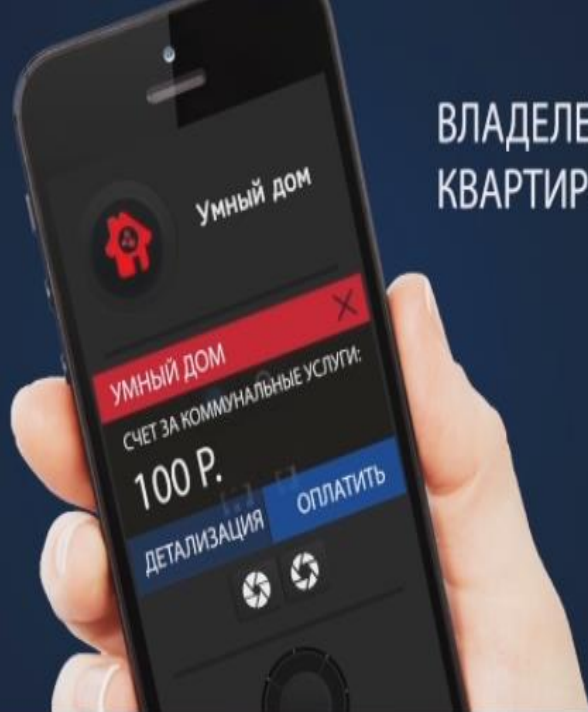



Энергомера

- OnLine
- Pass
- FreshData
- MaxMin

3
ParamRequest

- Добавить элемент
- Удалить элемент
- Свойства элемента

P: 0.310810

4 час 33 мин 48 сек 5 д.нед. 25 дата 5 мес 2018 год

23755.24
Общая энергия T0

16889.82
Энергия T1, кВт ч

6865.42
Энергия T2, кВт ч

График
электропотребления



система:
26.05.2018
03:04:07



График электропотребления

50
кВтч

OFF
Месяцы

2 5
День Месяц

ON
Дни

29.2
Значение, кВтч

OFF
T1

OFF
T2

- 24 +
Прокрутка

В сегодня
В конец

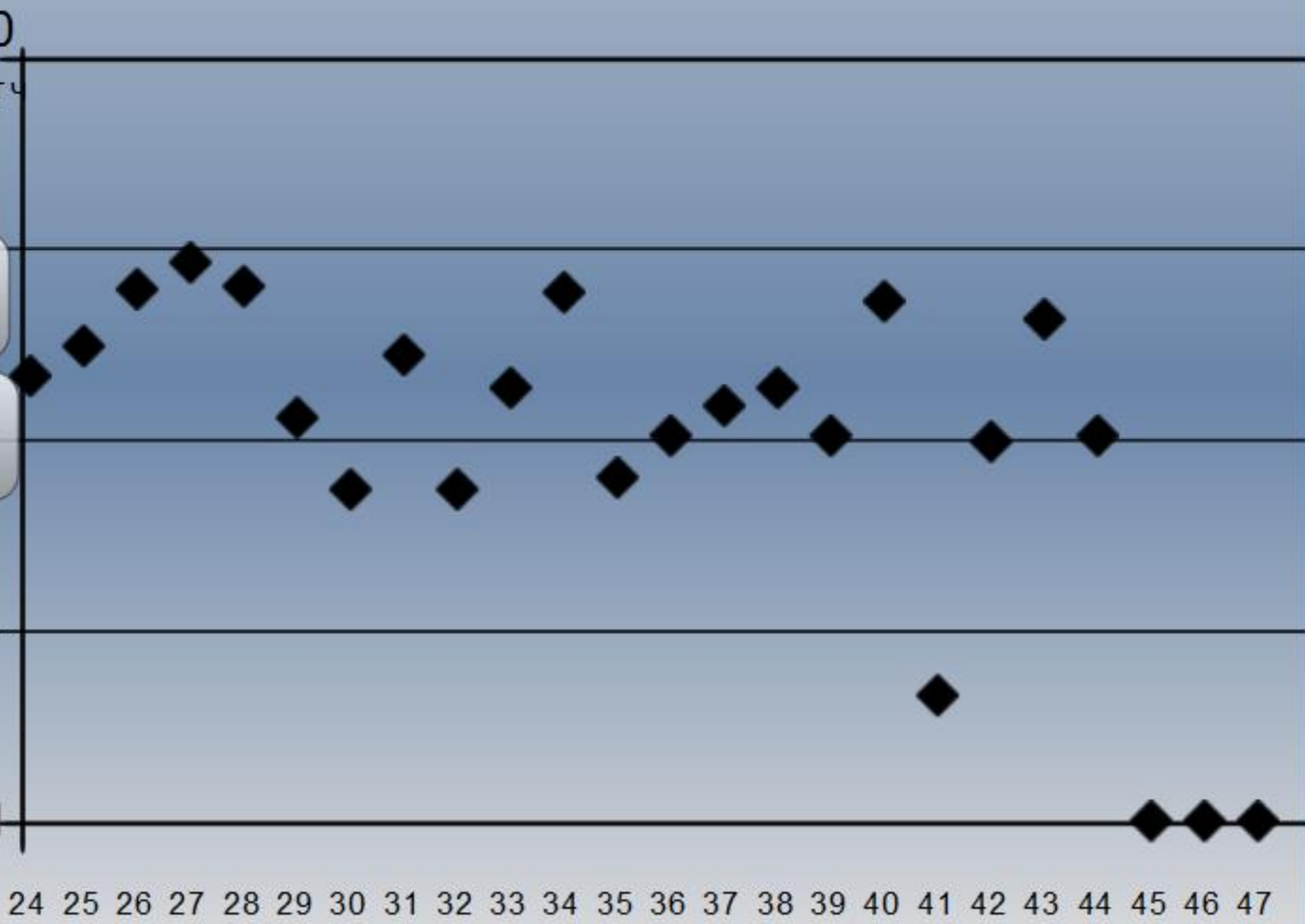

24 25 26 27 28 29 30 31 32 33 34 35 36 37 38 39 40 41 42 43 44 45 46 47

ВОЛД

СИСТЕМЫ БЕЗОПАСНОСТИ



Разумный Дом

RD

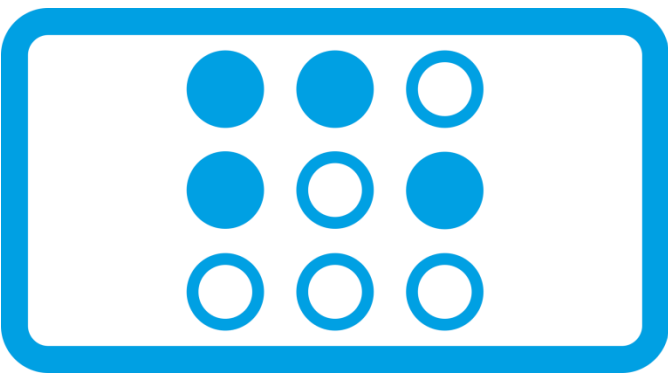

**iRidium
mobile**

0.81



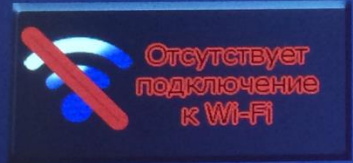

Отсутствует
подключение
к Wi-Fi

EasyHome

HOMELOGICSOFT

Гостинная

лампа	пгора	вент-я
скорость	вкл	конди-р
нагрев	Авто Ручн режим	циркуляц

14:08:39

← НА ГЛАВНУЮ



система:
25.05.2018
04:29:29



Видеокамеры

EasyHome6.0



Звонок



Замок





Датчик движения



Контроль освещения



Контроль температуры
воздуха



Кондиционер

Датчик протечек воды



Спасибо за
внимание!

+7 (812) 642-05-98 8 (800) 555-29-06
kit@dom-automation.ru
kit.dom-automation.ru

